

UPCYCLE YOUR CARDBOARD BOXES INTO DESIGNER HOUSES

MATERIALS NEEDED

- Packaging materials, like cereal boxes etc.
- Coloured paper
- Glue sticks
- Scissors
- Colour pens (optional)

1

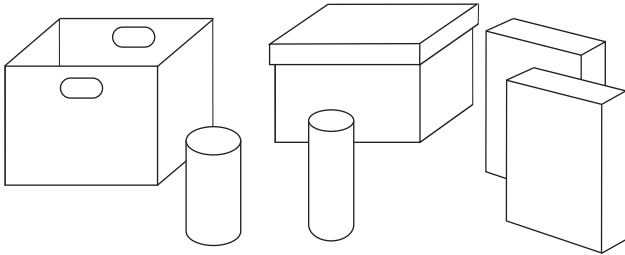

Find different sized boxes and cardboard tubes eg. cake, flour, shoe, cereal, postage

2

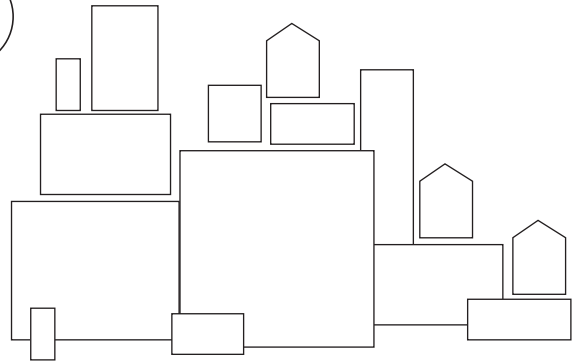

Arrange the boxes to make an interesting city.

3

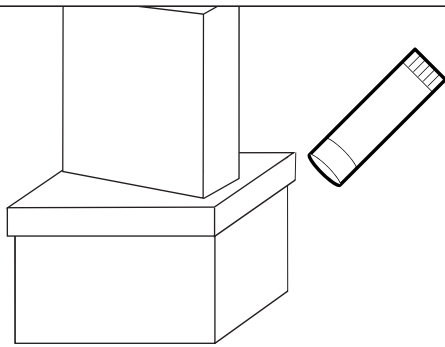

Glue boxes together. Make sure your city doesn't fall over!

4

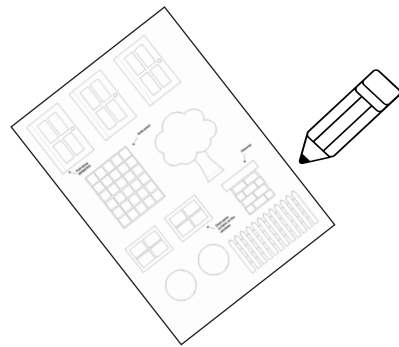

Print out the template of doors, windows and decorations and colour them in.

5

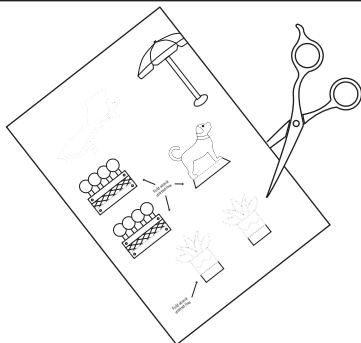

Cut around the outlines of the decorations. Fold along the dotted lines of the door and plant.

6

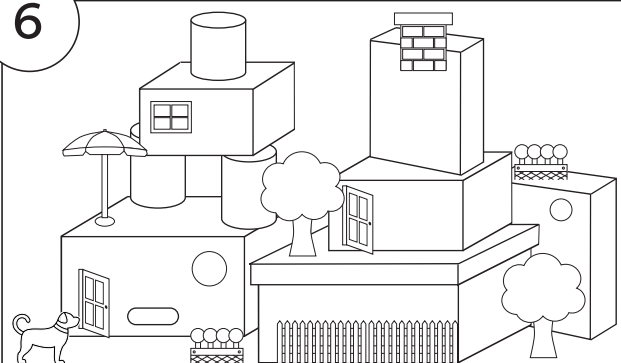

Glue onto the houses and buildings.

HOME HACK: If you want to add more features to your houses cut your own doors and windows out of coloured paper.

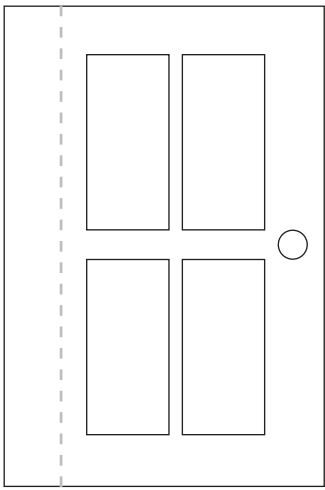

Fold along dotted line

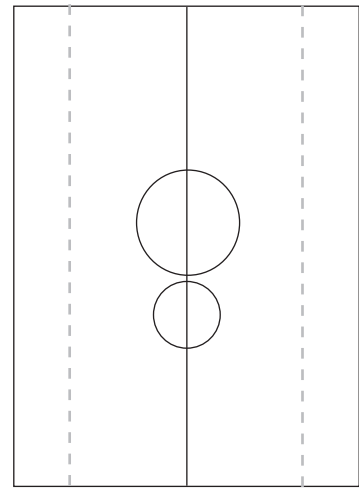
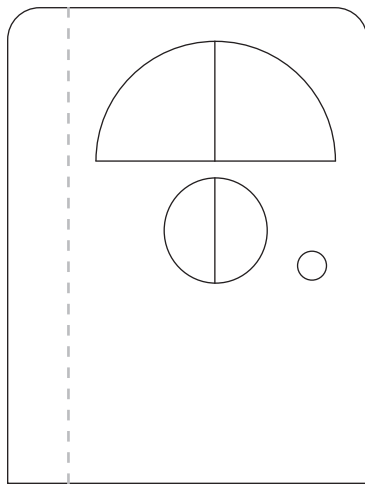

Cut the centre line of the door too

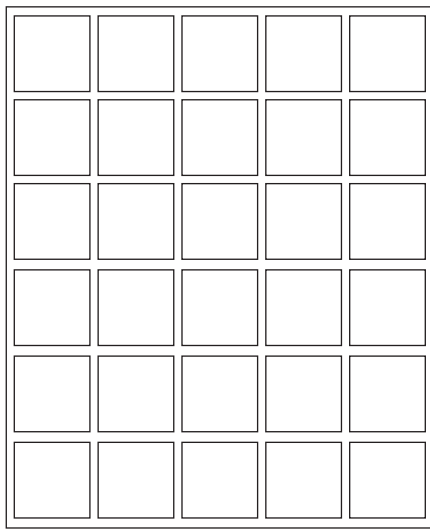

Solar panel

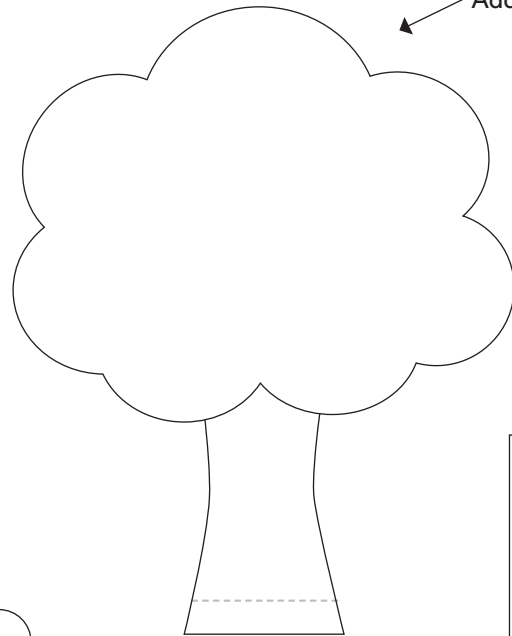

Add some birds

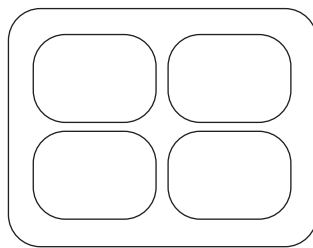
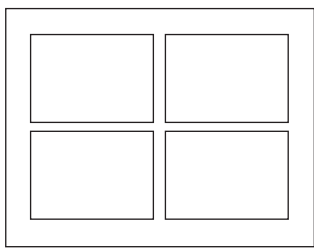

Add a light to your house

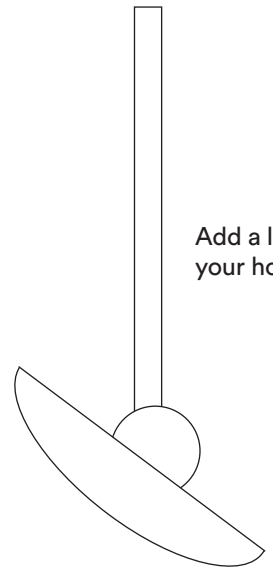

Draw some curtains in the windows

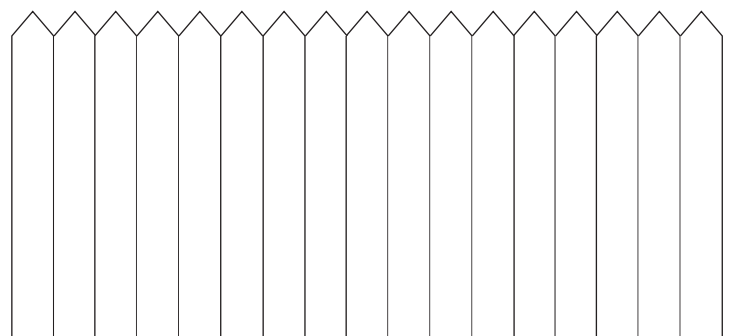
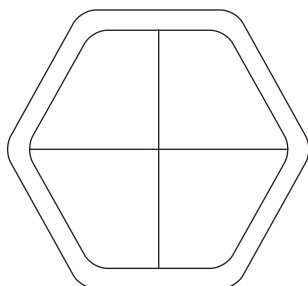
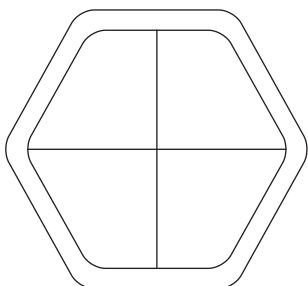

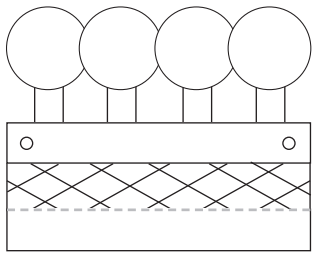
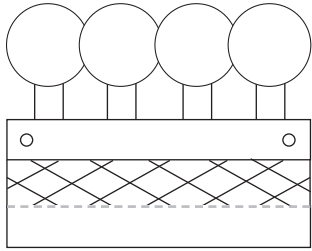
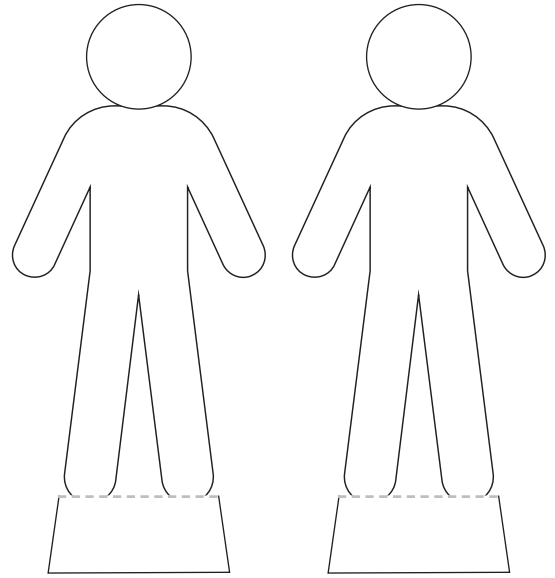

Fold along dotted line

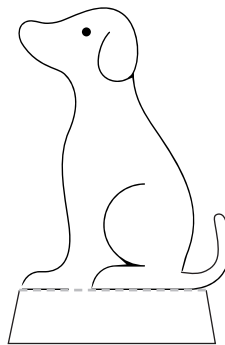

Draw clothes on the paper figures, cut out and fold along dotted line

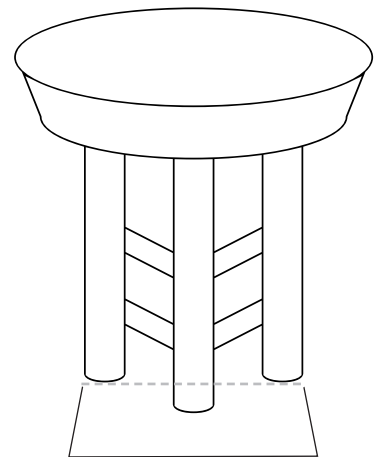

Fold along dotted line

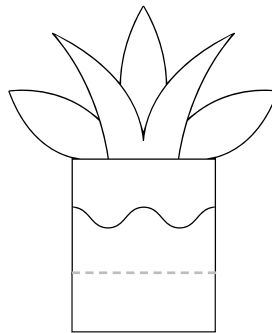
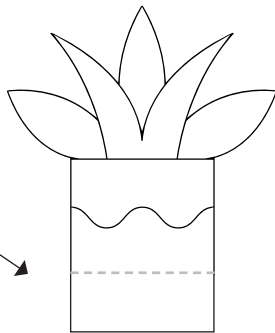

Does this chair look comfortable?

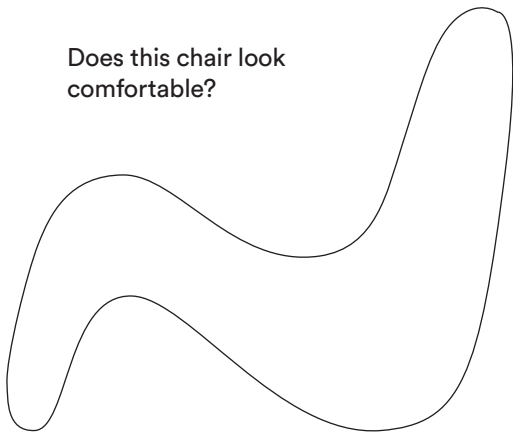

Fold along dotted line

