

# ROSIE DEACON TRAIN CONDUCTOR HAT

## MATERIALS NEEDED

- Paper templates (hat brim and crown, decorations and hat strap)
- 2 x A4 paper (or use the hat crown template provided)
- Scissors
- Stapler
- Glue stick
- Colour pencils to decorate

1

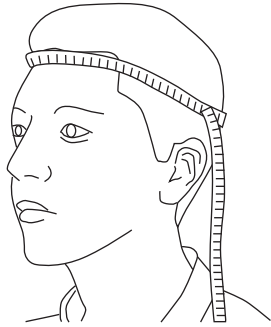

Measure the circumference of your head. Tip: you can use string if you don't have a tape measure.

2

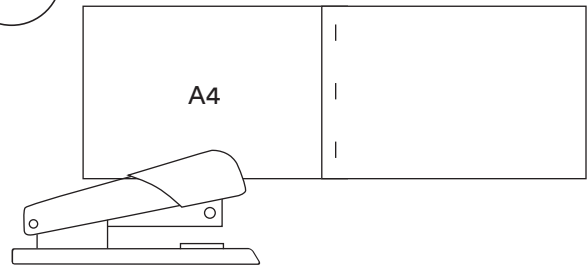

Staple the ends of two A4 pieces of paper together to make the hat crown or print the template provided.

3

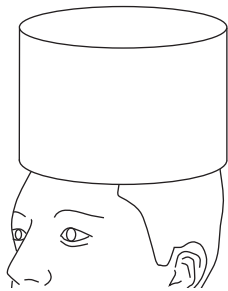

Fit the crown around your head then staple the other end together.

4

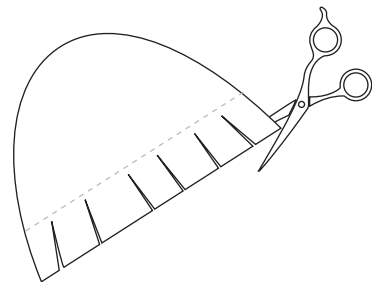

Print out the hat brim template and cut around the outline. The dotted line is the fold mark.

5

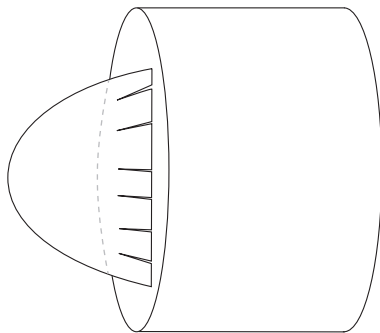

Glue the flaps to the inside of the hat crown

6

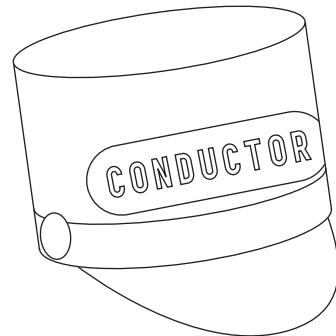

Print out the decorations template. Colour them in. Cut out the decorations and glue on the front of the hat.

You are finished!

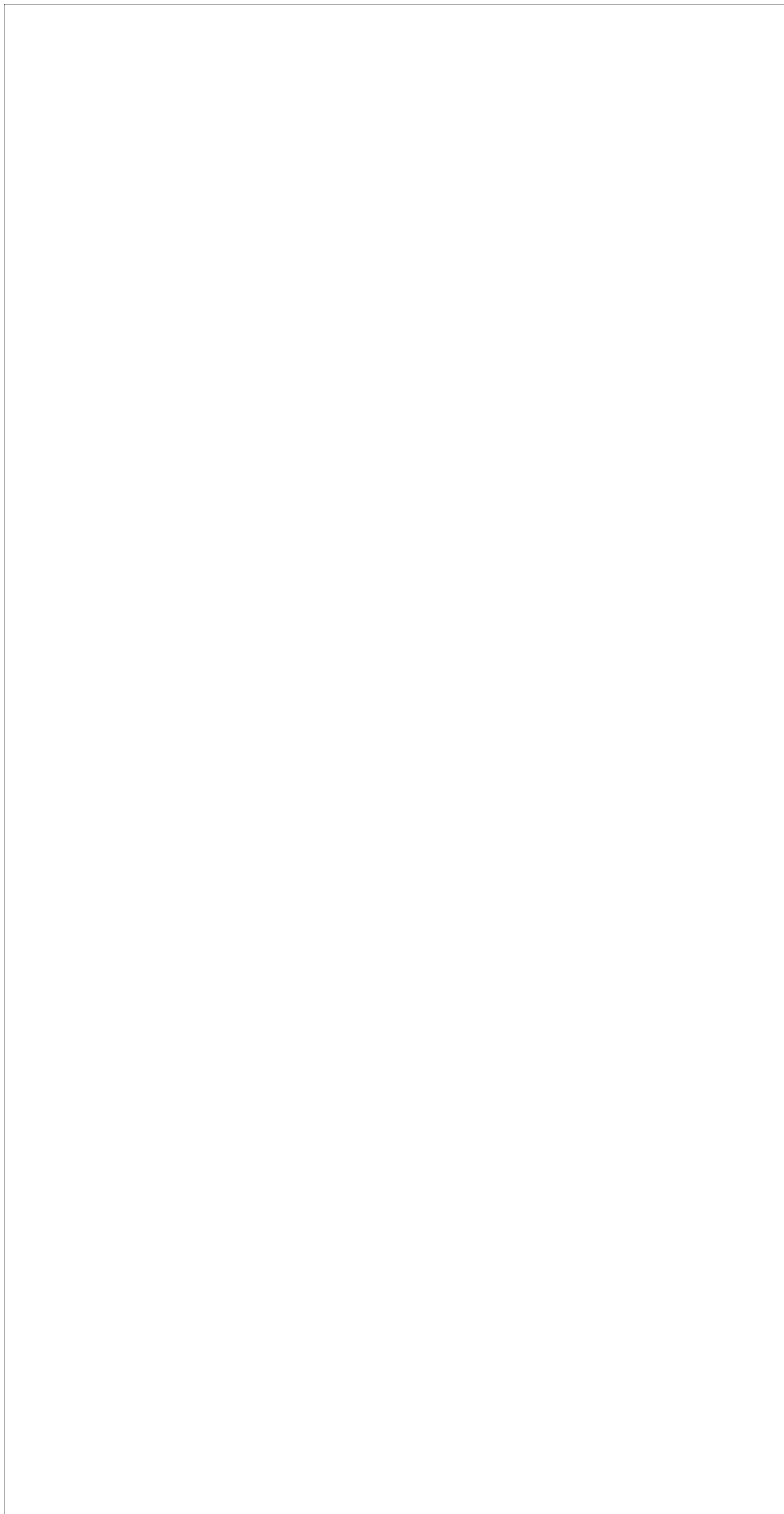

← Hat crown:  
Print this out twice.  
Use coloured paper  
if you have some.

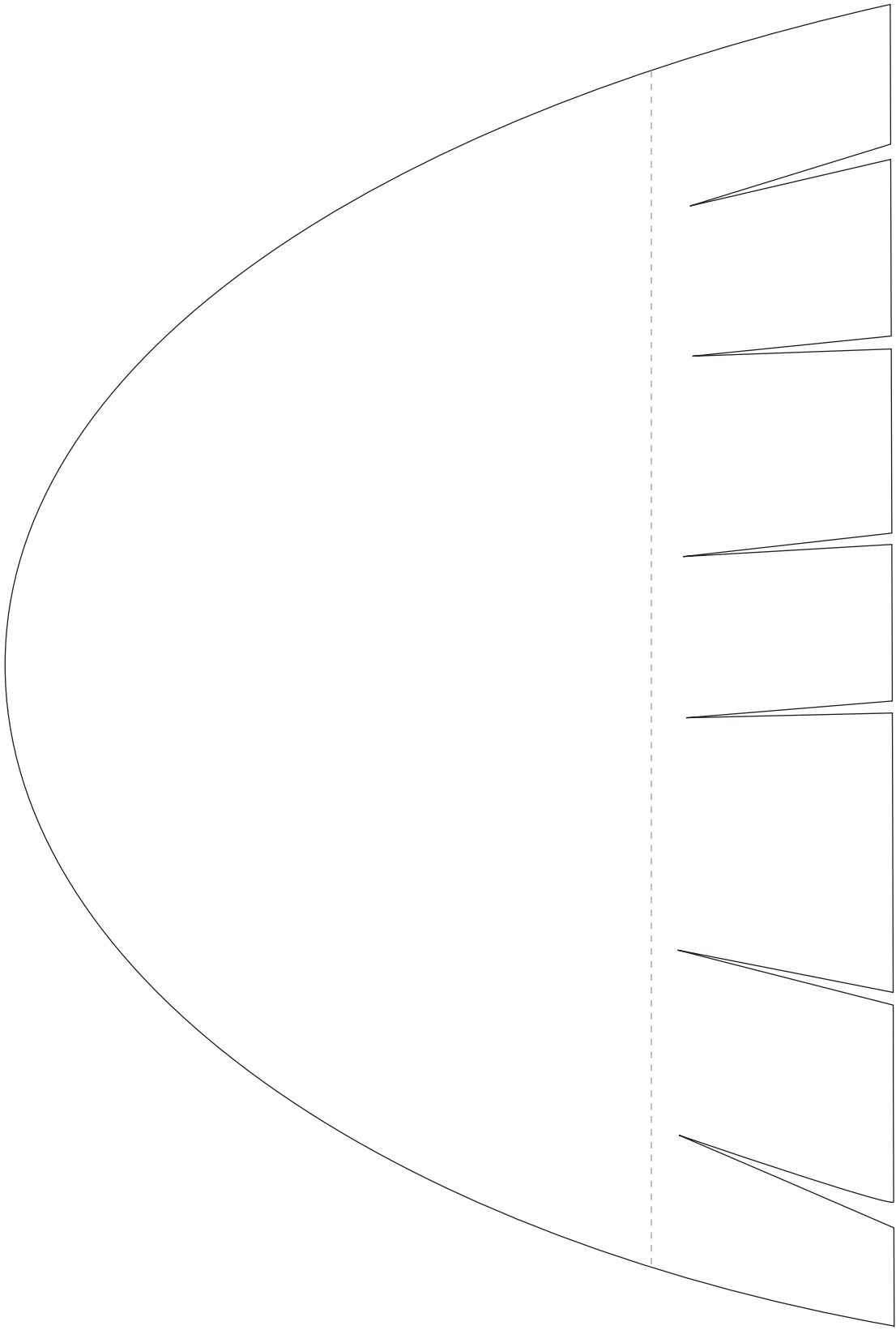

← Hat brim

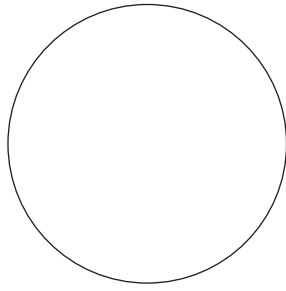
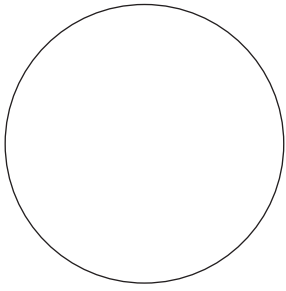

Colour in  
or decorate

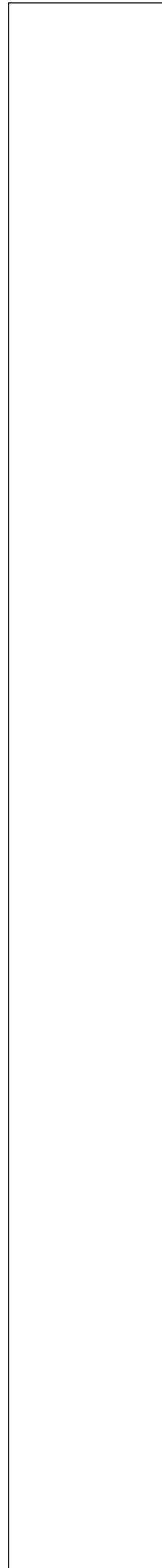
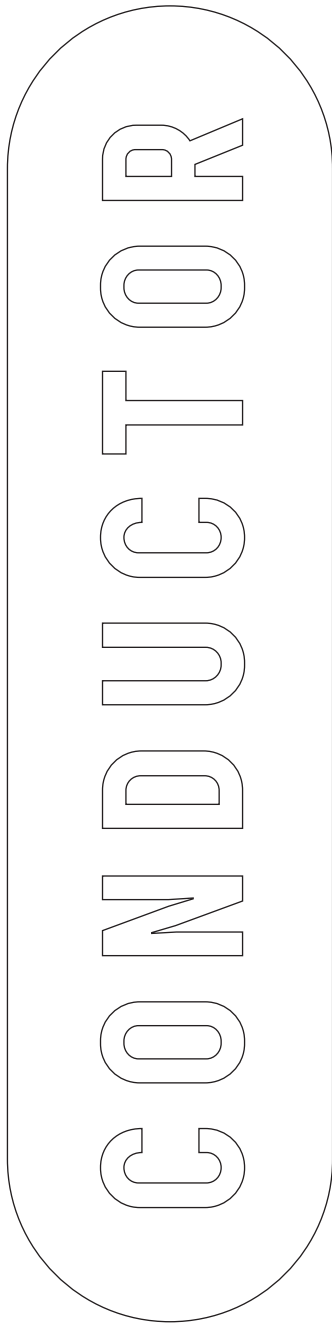

Hat strap